

Iris Power GuardII™

Condition Based Monitoring for Hydrogenerators and Pumped Storage Machines
Integrating Technologies for Stator and Rotor Related Health Assessment



WHY USE CONDITION BASED MONITORING

- **Extend Life of the Asset:** Condition based maintenance detects the onset of problems and repairs can be carried out before major damage occurs, thus extending the life of an asset.
- **Maximize Time between Outages:** Using Condition based maintenance, equipment is removed from service less frequently (it is only done if condition of machine is deteriorated) as compared to the other maintenance schemes.
- **Lower Repair Costs:** Repair costs in detecting problems at an early stage are often only 1% of the cost incurred if failure occurs during normal operation of an asset .
- **Predict Catastrophic Failures:** Maximize revenue from the generator by reducing risk of catastrophic asset failures and schedule maintenance activities to minimize outage cost.
- **Reduce Risk of Damage during Outage:** During disassembly, outage and assembly there is always a risk that inadvertent damage will be done to one of the machine's components. Minimizing the number of these outages reduces this risk.
- According to US Department of Energy (EERE)*, independent surveys suggest the following industrial average savings from initiation of a functional predictive maintenance:
 - Reduction in Maintenance cost : 25% to 30%
 - Reduction of Breakdowns: 70% to 75%
 - Reduction in downtime: 35% to 45%
 - Return on Investment: 10 times

*Source; US Department of Energy
(Website: <http://www1.eere.energy.gov>)

IRIS POWER GuardII for Hydrogenerators

Qualitrol-Iris Power specializes in providing measurement technology to detect various parameters which can be used for trending and assessing the stator and rotor condition in a hydrogenerator or a pump storage generator. To implement condition based maintenance, we measure and detect one or more of the following:

- Partial Discharge (PD) in stator winding insulation,
- Rotor magnetic flux,
- Air gap between stator and rotor

Iris Power GuardII is a continuous on-line monitor that has the ability to monitor multiple issues in hydrogenerators. The GuardII system has a flexible, modular design that can incorporate a variety of technologies and sensor inputs to meet your rotating machine needs based on the most common failure processes for your specific asset.

For example, one of the most common failures in hydrogenerators is the stator winding insulation. Thus, one of the major components of the GuardII system can be Partial Discharge (PD) monitoring.

GuardII not only monitors PD using Iris Power sensors but also uses condition-based data collection triggers and alert notifications, so that if the PD levels change, then the maintenance personnel can receive notification of something happening within their machine.

Another common failure process, is the development of shorted turns in salient pole rotors. For that, the GuardII system includes the ability to monitor the rotor flux. If desired, Iris Power GuardII can also monitor stator endwinding vibration.

Iris Power GuardII can continuously monitor on-line rotor magnetic flux which is used to detect and alert the presence of shorted rotor winding turns in salient pole machines such as hydro and pump storage generators. This system collects and analyzes flux data from any flux probe in real time, providing the pole location of any shorted turns.

Iris Power GuardII system can continuously monitor the stator for Partial Discharge activity and acquires PD data automatically, solving the problem of performing PD data collection under changing load and temperature conditions. Alerts are based on Iris Power's extensive database.

The Iris Power AGTracII is an effective tool for on-line monitoring of the air gap. The system is used to permanently monitor a hydrogenerator on-line and capture data in real-time during operation.

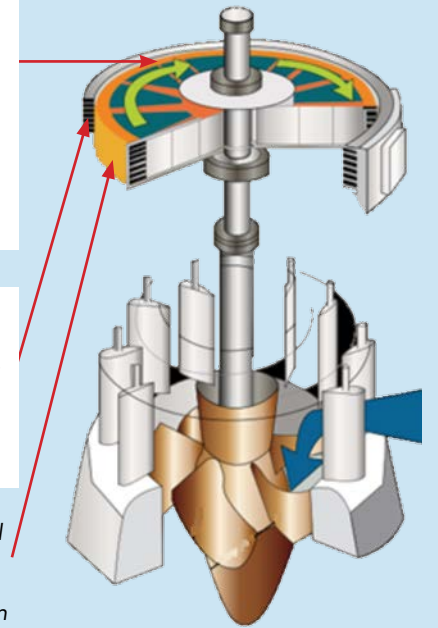

The PD and flux monitors are controlled using the Iris Application Manager™ (IAM) software. The IAM is a single platform to configure, download, and view data so that one would only need to learn a single software application. It can be used across several assets regardless of type of the asset. IAM can be used for hydrogenerators, turbogenerators and motors – each configured

specifically for your needs both today and for expansion in the future. The archived data can be downloaded locally over a USB port or remotely over a TCP/IP network communication. Ethernet connectivity allows personnel in distant offices to define or change data trigger conditions and alert levels, as well as to download results remotely for analysis using external viewing software created uniquely for each technology.

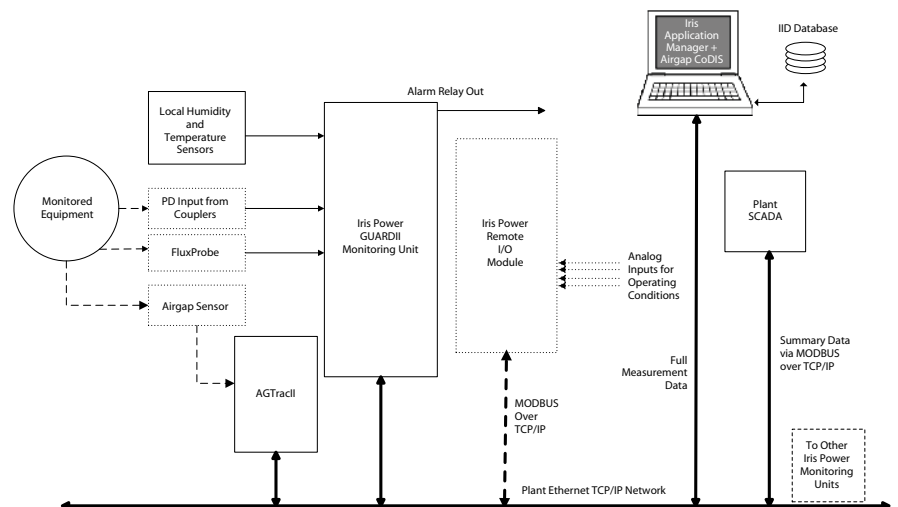

IRIS POWER GuardII for Hydrogenerators

IRIS APPLICATION MANAGER (IAM)

The Iris Power GuardII includes the IAM software which is a Windows™ based software suite for configuring the PD and/or flux modules, downloading the archived data, and viewing and trending the data collected by the data acquisition unit. Features include:

- Provide at-a-glance status information for every asset in a database.
- Ability to monitor multiple plants, assets and technologies.
- Download data/diagnostics from GuardII and TracII monitors.

- Add/Configure assets, sensors, continuous and portable monitors.

- Ethernet connectivity allows personnel in distant offices to remotely collect and analyze data.

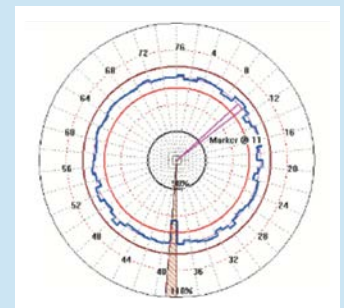
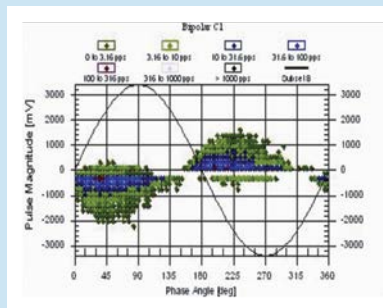
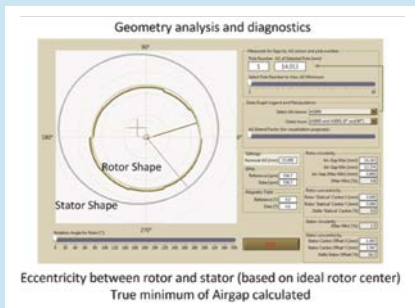
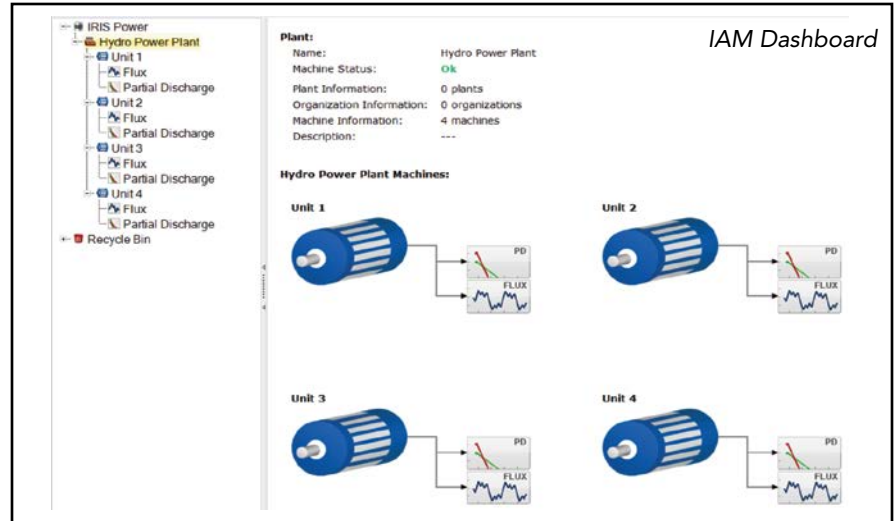

Comprehensive analysis on single screen

CODIS SOFTWARE FOR AIR GAP MONITORING

- Receives data from the real time module in pre-set time sequences and checks operating conditions.
- During transient mode of operation, data is recorded with increased time resolution.
- Alarm occurrence and alerts waveform data recording are saved to a database which can be used for post processing.
- Data analysis software shows the following:
 - On-line continuous diagnostic monitoring to plot air gap trend
 - Stator and rotor shape with eccentricity
 - Provides real time data for air gap maximum, minimum, and difference between two neighboring poles

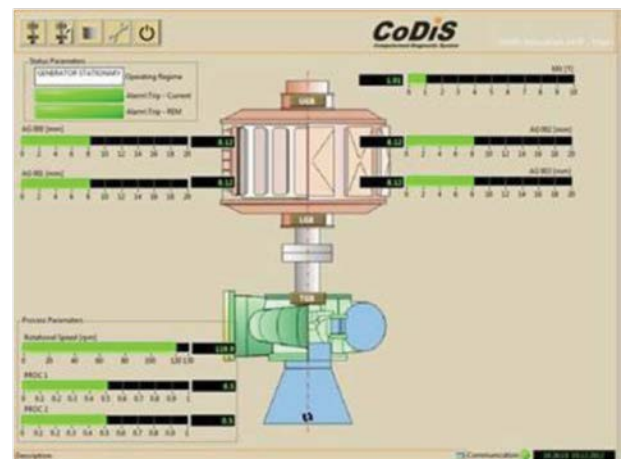

- Dynamic analysis of rotor
- Pole movement detection

IRIS POWER ON-LINE PRODUCTS

IRIS POWER GuardII for Hydrogenerators

BENEFITS OF IRIS POWER GUARDII CONDITION BASED MONITORING SYSTEM

Turnkey Solution for All Monitoring Technologies: Where facilities have existing sensors for PD, flux, and/or air gap sensors, GuardII and AGTracII monitor installation does not require an outage and the installation effort is limited to providing power to the monitor, configuration, and if desired, running a communication link to a remote Windows computer. Combined with the Iris Application Manager (IAM), one can continuously collect data from multiple rotating machines. This lowers the burden on plant personnel to collect data.

Stator and Rotor Knowledge Leadership: With trained technical specialists and sales staff, Qualitrol-Iris Power is your single point of contact for all stator and rotor related monitoring solutions and support for a hydrogenerator. Qualitrol-Iris Power also has world-class machines experts to aid with data interpretation.

Flexible and Modular Platform: Additional technologies such as Shaft Voltage & Current monitoring and Endwinding Vibration monitoring are also available and can be field upgraded with the GuardII monitoring system. GuardII can combine up to 3 technologies based on user needs.

Third Party Interface: Modbus over Ethernet protocol included for interfacing to third party applications, e.g. machine operating condition data such as active power, reactive power, stator voltage, winding temperature, and/or send the

diagnostic summary values to plant SCADA systems.

Reliable Prediction: GuardII system has undergone unique and rigorously researched methods to overcome the electrical interference (noise) which is typical in most plant environments. This ensures reliable and repeatable

PD and flux measurements with a low probability of false alarms.

Customer Education: The data can be easily interpreted by a maintenance professional after participating in a training seminar offered by Qualitrol-Iris Power's experienced engineering staff.

What is Partial Discharge Monitoring?

Partial discharges (PD) are small electrical sparks that occur within the high voltage electrical insulation in stator windings. PD occurs whenever there are small voids in or on the surface of the insulation. Over 60 years' experience has shown that as a stator winding deteriorates from winding vibration, operation at high temperatures, or contamination from oil, moisture and other chemicals, the PD activity will increase by a factor of ten or more. Thus, on-line PD monitoring detects the main root causes of stator winding failure. Since PD monitoring can be performed during normal motor or generator operation, and generally gives two or more years of warning of a risk of failure, online PD monitoring has become a very powerful tool for condition-based maintenance. PD is a symptom of abrasion of insulation, loose wedges, thermal degradation, manufacturing defects—all of which could lead to stator winding insulation failure if not detected and repaired early.

What is Magnetic Flux Monitoring?

Monitoring rotor flux provides information on the integrity of the rotor winding interturn insulation. This information is critical in planning maintenance, explaining abnormal vibrations and verifying new and rewind rotor integrity. Magnetic flux signals are acquired from a probe permanently mounted on the machine stator.

A shorted turn means the insulation of the winding is deteriorated or burned and hence the current no longer takes the designed path. A turn-to-turn short is the most frequent rotor insulation failure mechanism and can result in:

- Thermal imbalance of the rotor pole and spider leading to increased mechanical vibration
- Magnetic imbalance in the flux resulting in mechanical vibration
- Inability to reach the rated MVA for that machine
- Rotor ground insulation failure

What is Air Gap Monitoring?

Air gap is the physical distance between the rotor and the stator which is usually only about 1cm in large hydrogenerators. This air gap can change as a result of various conditions:

- Static eccentricity generates static magnetic forces resulting in shaft bending or movement of the rotor center.
- Dynamic eccentricity results in vibrations of the rotor in the air gap and mechanical and electrical unbalance.

Electrical unbalance is caused by uneven rotor geometry or a localized problem in the rotor winding. Eccentricity is the measurement of how much the rotor deviates from being circular. Through monitoring of the air gap the following faults and conditions may become evident: electrical unbalance, misalignment, impending rotor rub, geometry problems, loose poles, rotor winding electrical insulation problems, and excessive stator movement problems. The air gap is influenced by: rapid starts and stops, unit loading, magnetic forces, thermal forces, and centrifugal forces exerted on the rotor.

Iris Power GuardII, Iris Power AGTracII, Iris Power IAM, Iris Power CoDiS are trademarks of Qualitrol-Iris Power. Windows is a registered trademark of Microsoft Corporation in the United States and other countries.

QUALITROL-IRIS POWER HAS BEEN THE WORLD LEADER IN MOTOR AND GENERATOR WINDING DIAGNOSTICS SINCE 1990, PROVIDING A FULL LINE OF ON-LINE AND OFF-LINE TOOLS, AS WELL AS COMMISSIONING AND CONSULTING SERVICES.



A QUALITROL Company

www.irispower.com

www.qualitrolcorp.com

Iris Power LP
3110 American Drive
Mississauga, ON, Canada L4V 1T2
Phone: +1-905-677-4824
Fax: +1-905-677-8498
Sales.iris@qualitrolcorp.com

Qualitrol Company LLC
1385 Fairport Road
Fairport, NY, USA 14450
Phone: +1-585-586-1515
Fax: +1-585-377-0220



QUALITROL
Defining Reliability

Ver 2 • 7/14